

Dotline

Design by Tommaso Caldera

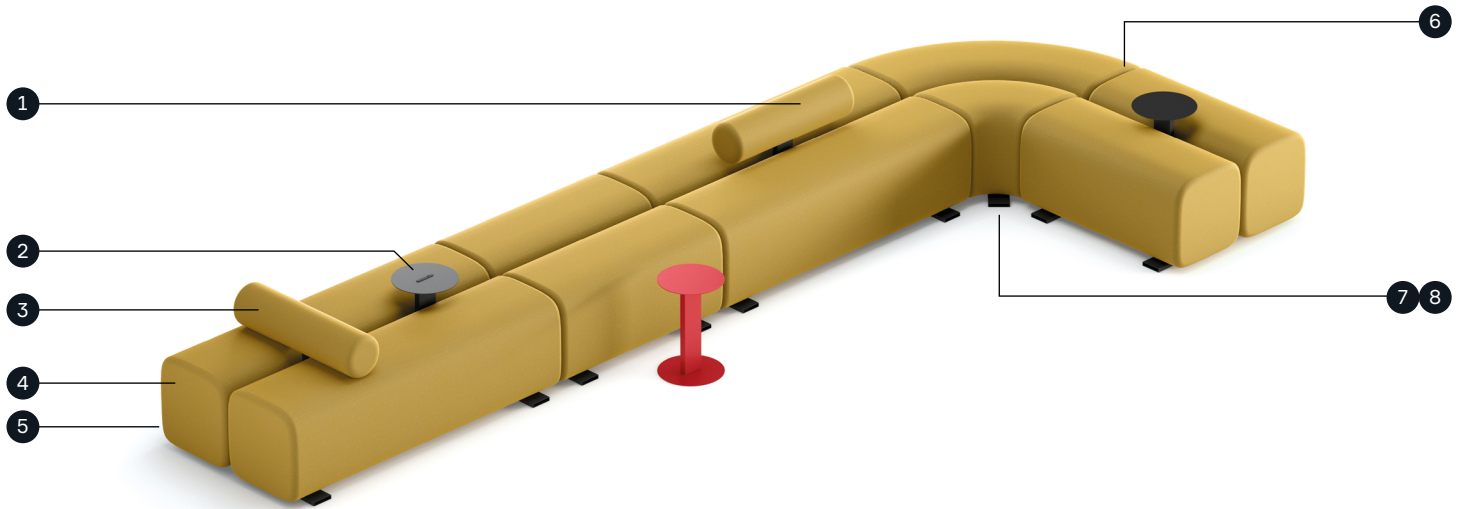



❶ Schienale: struttura interna in poliuretano espanso sagomato.

❷ Tavolino con piano in lamiera d'acciaio sp. 5 mm e colonna in tubo d'acciaio 100x30x2 mm Nero RAL 9005.
Optional: punto di ricarica 1xUSB A + 1xUSB C nero.

❸ Bracciolo: struttura interna in poliuretano espanso sagomato.

❹ Struttura interna in polistirolo con piano inferiore in truciolare.

❺ Rivestimento struttura in poliuretano espanso.

❻ Gancio di unione maschio + femmina zincato.

❼ Struttura in tubo d'acciaio 100x20x2 mm Nero RAL 9005.

❽ Solo per moduli curvi: piedini in polipropilene Nero RAL 9005 (4 piedini per curva singola, 8 piedini per curva doppia).

❶ Backrest: internal frame in shaped polyurethane foam.

❷ Table with 5 mm thk sheet steel top and 100x30x2 mm black RAL 9005 steel tube column.
Optional: Charging point 1xUSB A + 1xUSB C black.

❸ Armrest: internal frame in shaped polyurethane foam.

❹ Internal frame in polystyrene with lower surface in chipboard.

❺ Frame covering in expanded polyurethane.

❻ Zinc plated male + female joining hooks.

❼ Steel structure, tube 100x20x2 mm Black RAL 9005.

❽ For curved modules only: polypropylene feet Black RAL 9005 (4 feet for single curve, 8 feet for double curve).

❶ Dossier : structure interne en mousse de polyuréthane profilée.

❷ Table avec plateau en tôle d'acier ép. 5 mm et colonne en acier tube 100x30x2 mm Noir RAL 9005.
En option : borne de recharge 1xUSB A + 1xUSB C noir.

❸ Accoudoir : structure interne en mousse de polyuréthane profilée.

❹ Structure interne en polystyrène avec plateau inférieur en aggloméré.

❺ Revêtement de structure en mousse de polyuréthane.

❻ Crochet d'union mâle + femelle galvanisé.

❼ Structure en tube d'acier 100x20x2 mm Noir RAL 9005.

❽ Uniquement pour modules courbes : pieds en polypropylène noir RAL 9005 (4 pieds pour une courbe simple, 8 pieds pour une double courbe).

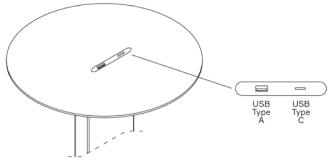

BOX12

Punto di ricarica su tavolino:

(1x USB Type A) + (1x USB Type C). Nero.

BOX12

Charging point on table top:

(1x USB Type A) + (1x USB Type C). Black.

BOX12

Borne de recharge sur table:

(1x USB Type A) + (1x USB Type C). Noir.

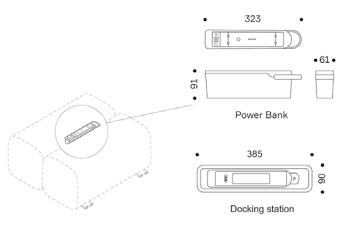

BOX13 *

Punto di ricarica con sistema a batteria rimovibile.

(1x USB Type A) + (1x USB Type C). Nero.

BOX13 *

Charging point with removable power bank system.

(1x USB Type A) + (1x USB Type C). Black.

BOX13 *

Borne de recharge avec système de batterie externe amovible.

(1 port USB Type A) + (1 port USB Type C). Noir.

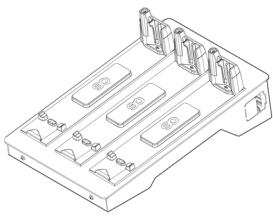

BOX13_CS

Charging station per BOX13 (Max 3 Power Banks). Nero.

BOX13_CS

Charging station for BOX13 (Max 3 Power Banks). Black.

BOX13_CS

Charging station pour BOX13 (Max 3 Power Banks). Noire.

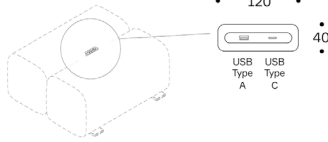

BOX14 *

Punto di ricarica su torretta:

(1x USB Type A) + (1x USB Type C). Nero.

BOX14 *

Charging point on turret:

(1x USB Type A) + (1x USB Type C). Black.

BOX14 *

Borne de recharge sur la tourelle:

(1x USB Type A) + (1x USB Type C). Noir.

* Disponibile solo per modelli 100D e 160D.
Available only for models 100D and 160D.
Disponible uniquement pour les modèles 100D et 160D.

Finiture

Finishes / Finitions

**FINITURE
STRUTTURA / TAVOLINO**

**FRAME / TABLE
FINISHES**

**FINITIONS
STRUCTURE / TABLE**

Verniciato / Painted / Verni



RAL 9005

Nero
Black
Noir

FINITURE TESSUTO

FABRIC FINISHES

FINITION TISSU

F1*

F2

F3**

F4

* Non disponibile: Surround

** Non disponibile: Grisù.

* Not available: Surround

** Not available: Grisù.

* Non disponible: Surround

** Non disponible: Grisù.

OMOLOGAZIONE CLASSE 1

Omologazione alla classe di
reazione al fuoco 1IM (solo per F1-
Mirage, F2-Roccia)

DOTLINE 100S

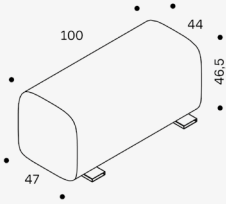

DOTLINE 160S

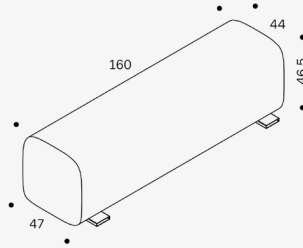

DOTLINE 108C_DX

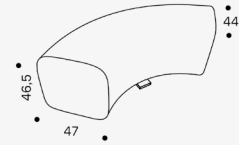

DOTLINE 108C_SX

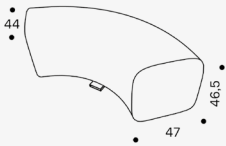

DOTLINE 108C_XX

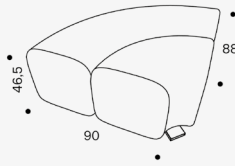

DOTLINE 100D

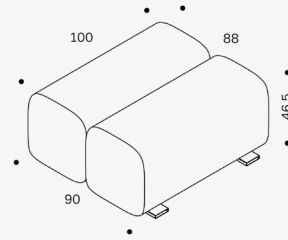

DOTLINE 160D

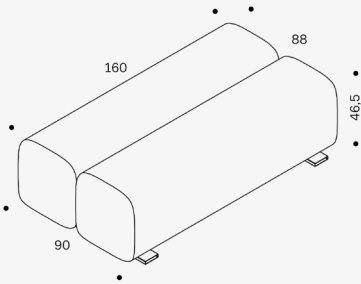

DOTLINE 100D_A1

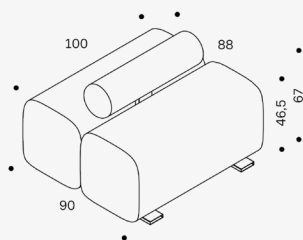

DOTLINE 160D_A1

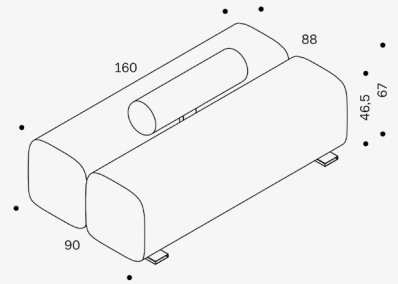

DOTLINE 100D_B1

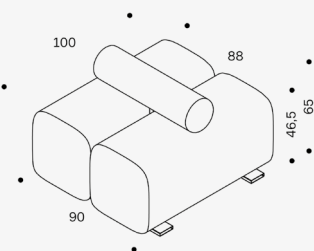

DOTLINE 160D_B1

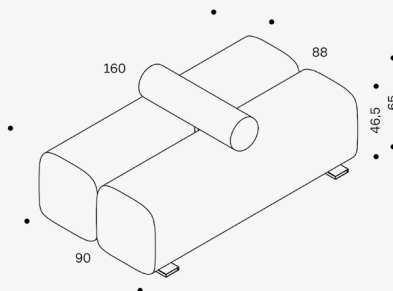

DOTLINE 100D_B2

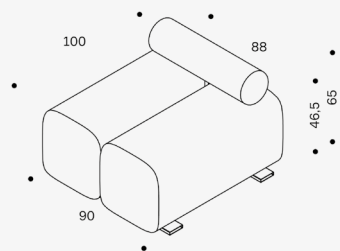

DOTLINE 160D_B2

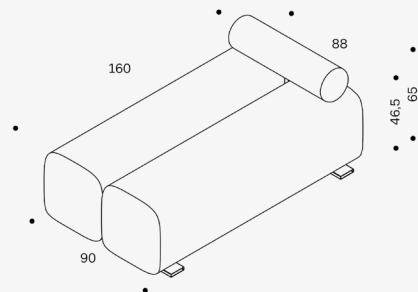

DOTLINE 160D_B3

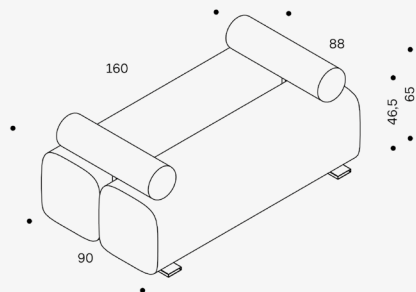

DOTLINE 100D_C1

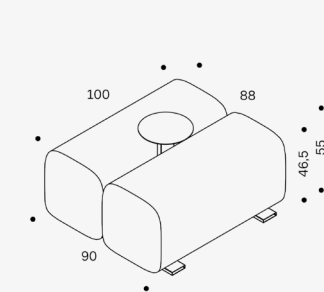

DOTLINE 160D_C1

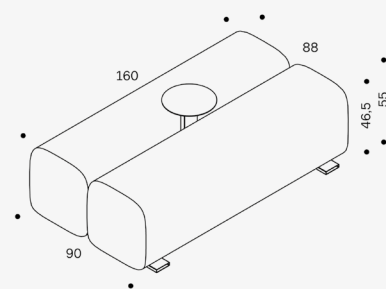

DOTLINE 100D_C2

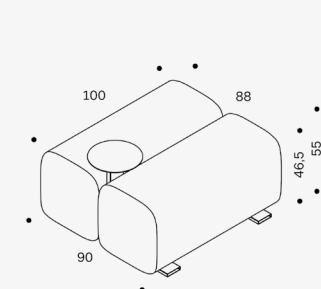

DOTLINE 160D_C2

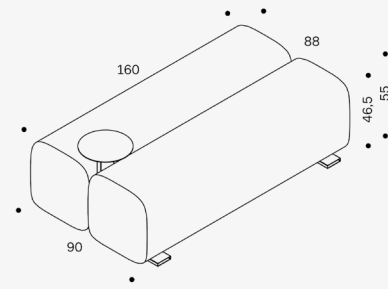

DOTLINE 160D_C3

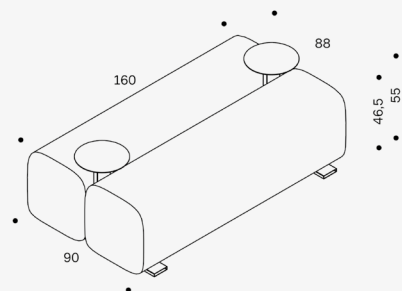

DOTLINE 100D_X1

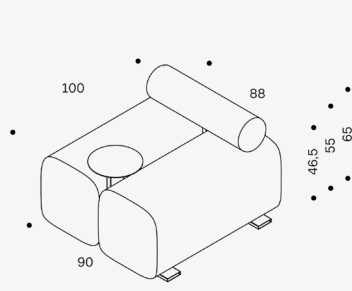

DOTLINE 160D_X1

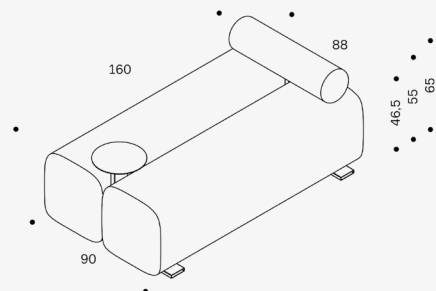

DOTLINE 160D_X2

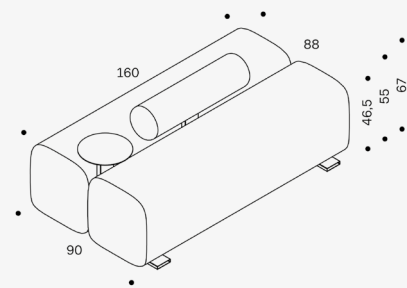

DOTLINE 160D_X3

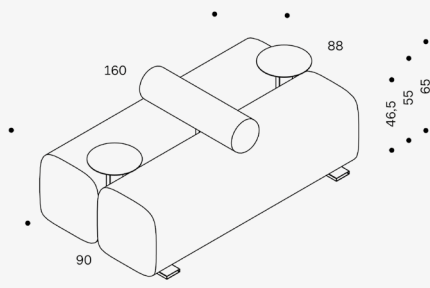

DOTLINE 160D_X4

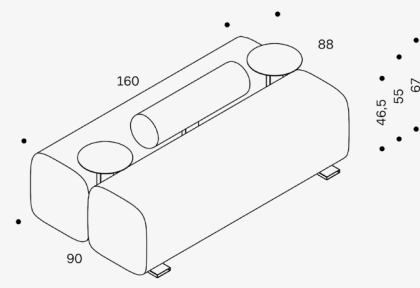

Disegni Tecnici

Technical Drawings / Dessins Technique

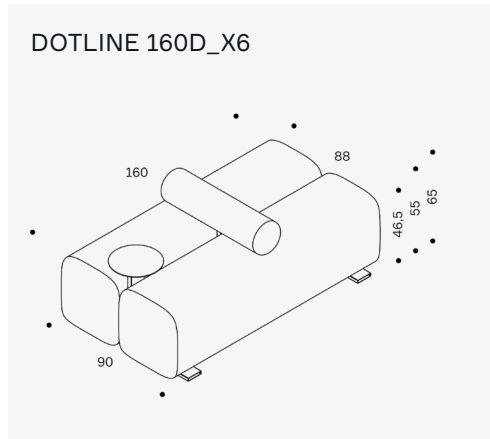
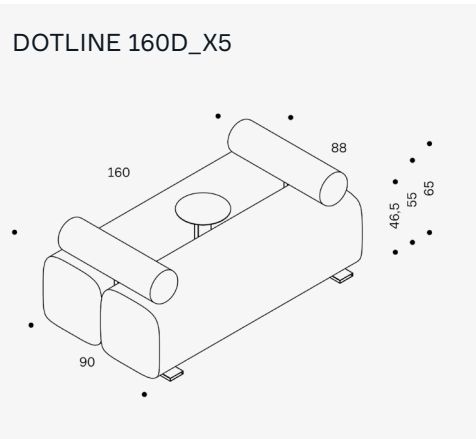

Note

Notes / Note

Pulizia

Per le parti metalliche consigliamo esclusivamente un panno morbido e alcool asciugando bene dopo la pulizia. Per le superfici in plastica, usare panno umido ed acqua con detersivo liquido neutro, non usare solventi, trielina, acetone o ammoniaca.

Cleaning

For the metal parts we recommend only a soft cloth and alcohol, drying well after cleaning. For plastic surfaces, use a damp cloth and water with neutral liquid detergent, do not use solvents, trichlorethylene, acetone or ammonia.

Nettoyage

Pour les parties métalliques, nous recommandons uniquement un chiffon doux et de l'alcool, bien sécher après le nettoyage. Pour les surfaces en plastique, utilisez un chiffon humide et de l'eau avec un détergent liquide neutre, n'utilisez pas de solvants, de trichloréthylène, d'acétone ou d'ammoniac.

Garanzia

I nostri prodotti sono garantiti 1, 5 e 10 anni (testo integrale della garanzia su richiesta). Un uso improprio del prodotto preclude la garanzia dello stesso.

Warranty

We provide a 1, 5 and 10 years warranty for our products (full text of the guarantee on request). Improper use of the product precludes its warranty.

Garantie

Nos produits sont garantis 1, 5 et 10 ans (texte complet de la garantie sur demande). Une mauvaise utilisation du produit exclut sa garantie.

Uso improprio

Non sono consentiti: Modifiche strutturali e/o manomissioni al prodotto.

Improper use

The following are not allowed: Structural changes and / or product tampering.

Utilisation incorrecte

Les éléments suivants ne sont pas autorisés : Modifications structurelles et/ou altération du produit.

Dotline Tav

Design by Tommaso Caldera



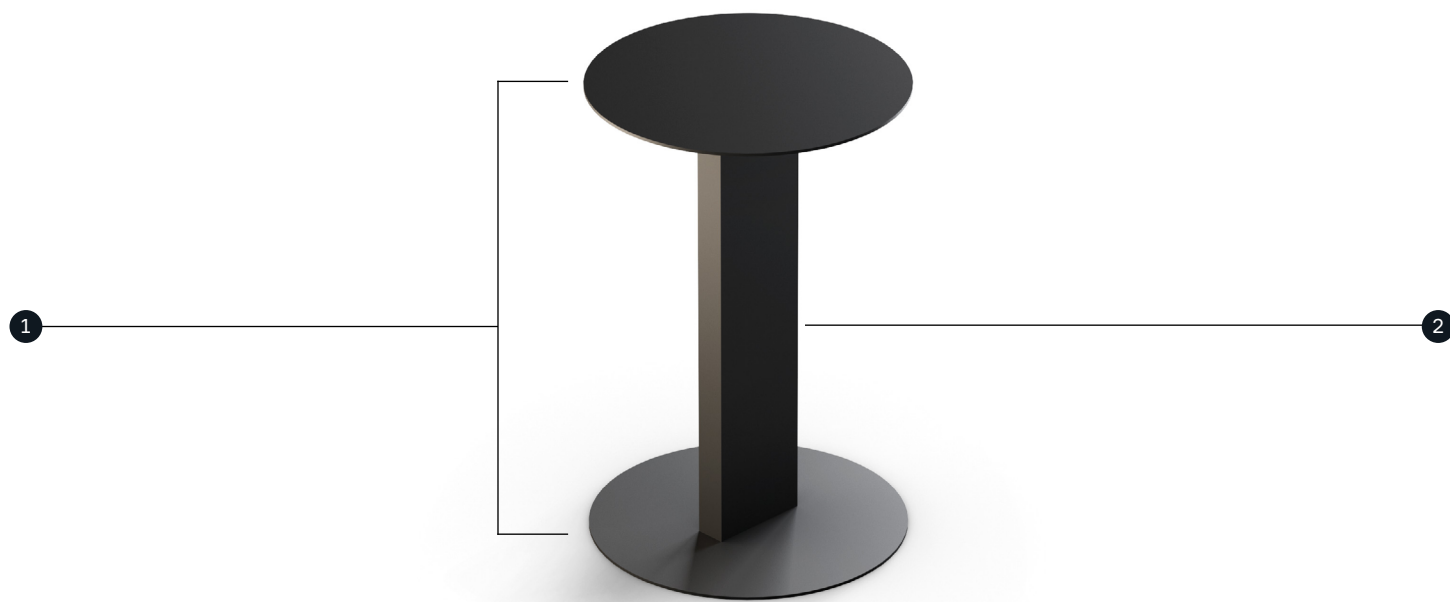

❶ Piano e basamento in lamiera d'acciaio sp. 5 mm verniciata a polveri Nero RAL 9005 o Rosso RAL 3000.

❷ Colonna in tubo d'acciaio, 100x30x2 mm verniciata a polveri Nero RAL 9005 o Rosso RAL 3000.

❶ Top and base in 5 mm thk sheet steel powder coated in Black RAL 9005 or Red RAL 3000.

❷ Column in steel tube, 100x30x2 mm powder coated Black RAL 9005 or Red RAL 3000.

❶ Plateau et base en tôle d'acier ép. 5 mm vernie à poudres Noir RAL 9005 ou Rouge RAL 3000.

❷ Colonne en tube d'acier 100x30x2 mm vernie à poudres Noir RAL 9005 ou Rouge RAL 3000.

Finiture

Finishes / Finitions

FINITURE STRUTTURA

Verniciato / Painted / Verni



RAL 9005
Nero
Black
Noir



RAL 3000
Rosso
Red
Rouge

FRAME FINISHES

FINITIONS STRUCTURE

Disegni Tecnici

Technical Drawings / Dessins Technique

DOTLINE TAV S

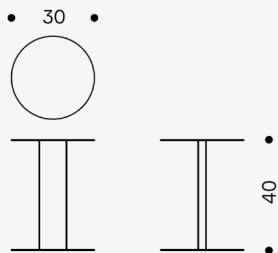

Note

Notes / Note

Pulizia

Per le parti metalliche consigliamo esclusivamente un panno morbido e alcool asciugando bene dopo la pulizia. Per le superfici in plastica, usare panno umido ed acqua con detersivo liquido neutro, non usare solventi, trielina, acetone o ammoniaca.

Cleaning

For the metal parts we recommend only a soft cloth and alcohol, drying well after cleaning. For plastic surfaces, use a damp cloth and water with neutral liquid detergent, do not use solvents, trichlorethylene, acetone or ammonia.

Nettoyage

Pour les parties métalliques, nous recommandons uniquement un chiffon doux et de l'alcool, bien sécher après le nettoyage. Pour les surfaces en plastique, utilisez un chiffon humide et de l'eau avec un détergent liquide neutre, n'utilisez pas de solvants, de trichloréthylène, d'acétone ou d'ammoniac.

Garanzia

I nostri prodotti sono garantiti 1, 5 e 10 anni (testo integrale della garanzia su richiesta). Un uso improprio del prodotto preclude la garanzia dello stesso.

Warranty

We provide a 1, 5 and 10 years warranty for our products (full text of the guarantee on request). Improper use of the product precludes its warranty.

Garantie

Nos produits sont garantis 1, 5 et 10 ans (texte complet de la garantie sur demande). Une mauvaise utilisation du produit exclut sa garantie.

Uso improprio

Non sono consentiti: Modifiche strutturali e/o manomissioni al prodotto.

Improper use

The following are not allowed: Structural changes and / or product tampering.

Utilisation incorrecte

Les éléments suivants ne sont pas autorisés : Modifications structurelles et/ou altération du produit.